

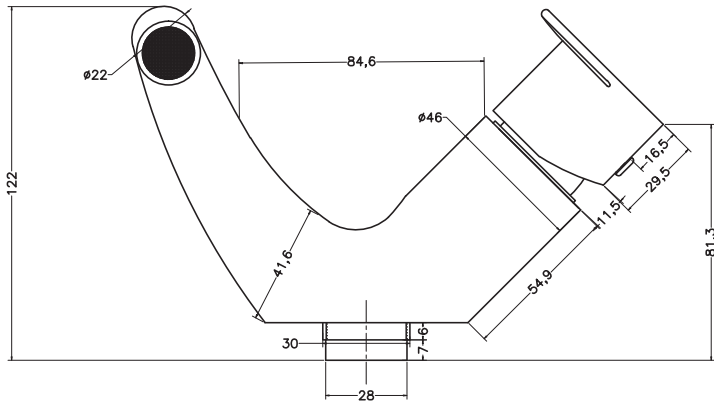

Unit : cm

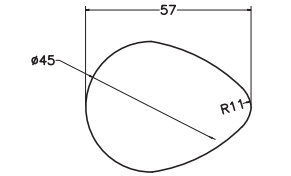

MAIN BODY ASSLY.



HANDLE TOP

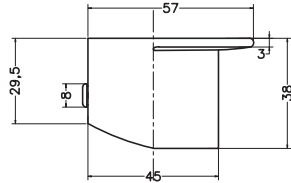

HANDLE SIDE VIEW

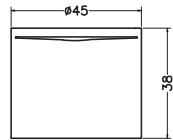

HANDLE FRONT VIEW

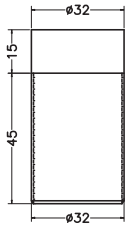

SHANK

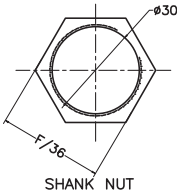
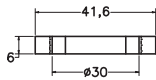

SHANK NUT

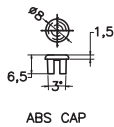

ABS CAP

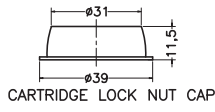

CARTRIDGE LOCK NUT CAP

ZINNIA	
Catalogue No.	: Q353111120
Item Description	: Single lever basin mixer
Product Raw Material	: Brass
ALL DIMENSIONS ARE IN MM	
Scale	NTS
Sheet Size	A4

This Drawing remain the property of QUEO. It must not, even in part, be reproduced or may available to unauthorised person without express concerned of QUEO.

*Queo is a registered trademark of Barwood, England, Uk.